

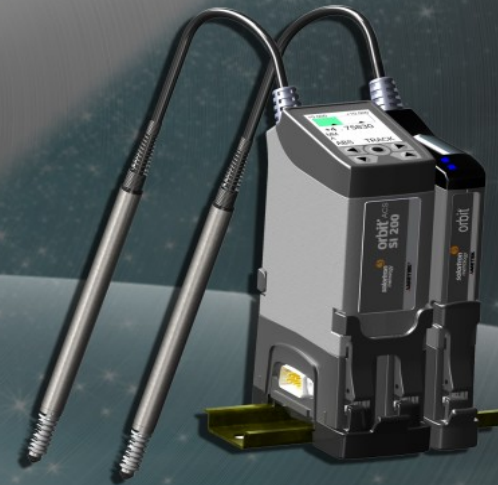

Solartron
Metrology

ORBIT[®] ACS

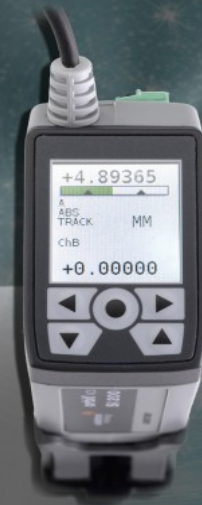

orbitACS

AMETEK[®]
ULTRA PRECISION TECHNOLOGIES

1 GENERAL

1.1 DOCUMENTATION CROSS REFERENCE

503083	SI100 & SI200 Data Sheet	
503174	SI400 Data Sheet	
503094	Orbit [®] ACS and Digital Probe and Linear Encoder User Leaflet	Detailing the specific requirements for using the Digital Probe or Linear Encoder (LE) such as mounting details
503145	Orbit LT Laser user leaflet	Detailing the specific requirements for using the Orbit LT laser such as product handling & configuration
503158	Orbit LTH Laser user leaflet	Detailing the specific requirements for using the Orbit LTH high performance laser such as product handling & applications
502914	Orbit Module Manual	Contains specific information for the Analogue Input Module (AIM)
503113	SI100 & SI200 Quick Keypad Guide	
503116	Orbit ACS Modbus Parameter Map – SI100/SI200	
503166	Orbit ACS Modbus Parameter Map – SI400	

1.2 TRADEMARKS AND COPYRIGHTS

Information in this document is subject to change without notice.

No part of this document may be reproduced or transmitted in any form or by means, electronic or mechanical, for any purpose, without the express permission of Solartron Metrology.

© 2015 Solartron Metrology Ltd. All rights reserved. Microsoft[®], Windows[®]XP, Windows[®]Vista, Windows[®]7, Windows[®]8, Windows[®]10, Excel[®], VBA and VB are registered trademarks or trademarks of Microsoft Corporation in the United States and/or other countries.

Orbit[®] is a registered trademark of Solartron Metrology Ltd

1.3 CONTACT INFORMATION

For updated information, troubleshooting guide and to see our full range of products, visit our website:
<http://www.solartronmetrology.com>

2 INTRODUCTION

This manual specifically caters for the Orbit ACS (Automation and Control System) products, SI100 and SI200, as well as the SI400 product via differences as specified in section 20 (SI400 Appendix).

2.1 SCOPE

The Orbit[®] ACS system provides products specifically designed to create small linear measurement systems with simple PLC interfacing or products which can be stand-alone readouts. Each module contains an integral LCD display and keypad for setting up and visual display of measurements. Basic Input output is provided by discrete lines or a serial interface configured in various ASCII formats or Modbus RTU over RS485 or RS232. For larger measurement systems, Solartron's Orbit Digital Measurement System which is a PC based system may be a more flexible solution.

The Orbit ACS system comprises three main types: the SI100, SI200 and SI400. These products are defined in the relevant data sheets.

2.2 NAVIGATE THIS DOCUMENT

Hyperlinks are included to aid navigation.



To return to the point where you have jumped from, most pdf readers have a 'Previous Page View' button, alternatively use the keyboard shortcut 'ALT' + left arrow key.

3 SAFETY SUMMARY

WARNING statements identify conditions or practices that could result in personal injury or loss of life.

CAUTION statements identify conditions or practices that could result in damage to the equipment or other property

Symbols in this manual



Indicates cautionary or other information

Warnings and Cautions

Warning: Do not operate in an explosive atmosphere.

Warning: this equipment is not intended for safety critical applications

Warning: do not exceed maximum ratings as specified in this document under individual modules.

Caution: Low Voltage

This equipment operates below the SELV and is therefore outside the scope of the Low Voltage Directive

Service and Repair



CAUTION: This equipment contains no user serviceable parts. Return to supplier for all service and repair

All of the Products are CE marked and comply with EN61000-6-3 Electrical Emissions and EN61000-6-2 Electrical Immunity and EN61326-1.

4 TABLE OF CONTENTS

1 GENERAL.....	2
1.1 DOCUMENTATION CROSS REFERENCE.....	2
1.2 TRADEMARKS AND COPYRIGHTS.....	2
1.3 CONTACT INFORMATION.....	3
2 INTRODUCTION.....	3
2.1 SCOPE.....	3
2.2 NAVIGATE THIS DOCUMENT.....	3
3 SAFETY SUMMARY.....	4
4 TABLE OF CONTENTS.....	5
5 GLOSSARY OF TERMS AND BASIC SYSTEM INFORMATION.....	9
5.1 TERMS ASSOCIATED WITH THE ORBIT ACS HARDWARE.....	9
6 MECHANICAL INSTALLATION.....	10
7 ELECTRICAL INSTALLATION.....	11
7.1 PC System Requirements.....	11
7.1.1 PC Hardware Requirements.....	11

7.1.2 PC Software Requirements.....	11
7.2 Installing the Orbit3 Support Pack for Windows® software.....	11
7.3 Connections.....	12
7.4 GROUNDING, CABLES AND POWER SUPPLIES.....	13
7.5 Noisy Electrical Environments.....	14
7.5.1 Residential, Commercial and Light Industrial Environments.....	14
7.5.2 Industrial Environments.....	14
8 CONFIGURATOR APPLICATION.....	14
9 FUNCTIONS AND DISPLAYS.....	16
9.1 SI100 and SI200 DISPLAYS.....	17
9.2 SI100 and SI200 ACTIONS.....	18
9.3 MENU SCREENS.....	22
9.3.1 Top Level Menu.....	23
9.3.2 Configure Probe(s).....	24
9.3.3 Probe Sub-menus.....	25
9.3.4 Measure Menu.....	27
9.3.5 Peak, Preset, Limits and Misc Menu.....	29
9.3.6 Output, Input and Communications Menu.....	30
9.4 COMMON ERROR MESSAGES & STATUS CODES.....	31
9.4.1 Display Error messages.....	31
9.4.2 Detachable Probes Error Messages.....	31
9.4.3 Modbus Errors.....	32
10 SECURITY LEVELS.....	33

11 OUTPUTS.....	34
12 DIGITAL INPUTS.....	35
12.1.1 Digital Inputs Configuration Options.....	35
12.1.2 Discrete Print Input.....	36
13 TIMING AND MEASUREMENT INFORMATION.....	38
14 SERIAL COMMUNICATIONS (GENERAL).....	39
14.1 RS232 and RS485 signal levels.....	39
14.2 TYPICAL RS232 WIRING.....	40
15 ASCII BASED SERIAL COMMUNICATIONS PROTOCOL.....	41
15.1 Orbit ACS Serial Communications Protocol.....	41
15.2 SI3500 Compatibility Protocol.....	44
15.3 SI1500 Compatibility Protocol.....	45
15.4 C55 Compatibility Protocol.....	46
15.5 ASCII Character Set.....	47
16 MODBUS BASED SERIAL COMMUNICATIONS PROTOCOL.....	48
16.1 INTRODUCTION.....	48
16.2 OVERVIEW OF MODBUS COMMUNICATIONS.....	48
16.2.1 Modbus Master/Slave.....	48
16.2.2 Modbus Unit ID.....	49
16.2.3 Parameters.....	49

16.2.4 Master Command Messages.....	50
16.2.5 Slave Unit Responses.....	51
16.2.6 Modbus Function Codes Supported by SI Products.....	52
16.2.7 Parameter Types.....	53
16.2.8 Parameter Map.....	54
16.2.9 ACS, Modbus Floating point	54
17 MEASUREMENT RESOLUTION, AVERAGING AND BANDWIDTH.....	55
18 MISCELLANEOUS.....	56
18.1 FIRMWARE UPGRADES.....	56
19 RETURN OF GOODS.....	57
20 SI400 APPENDIX.....	58
20.1 SI400 Summary.....	58
20.2 Section 9.1 - SI100 and SI200 DISPLAYS.....	58
20.2.1 Screen 1 & 2.....	58
20.2.2 Screen 3.....	59
20.3 Section 9.2 - SI100 and SI200 ACTIONS.....	60
20.4 SECTION 9.3 - MENU SCREENS.....	61
20.5 SECTIONS 11 - OUTPUTS & 12 - DIGITAL INPUTS.....	61
20.6 SECTION 15.1 - Orbit ACS Serial Communications Protocol.....	62
21 REVISION HISTORY.....	63

5 GLOSSARY OF TERMS AND BASIC SYSTEM INFORMATION

5.1 TERMS ASSOCIATED WITH THE ORBIT ACS HARDWARE

SI Series

The SI Series refers to all of the SI100, SI200 and SI400 products.

Display

The Liquid Crystal Display on the top of the SI Series modules providing displayed information

Keypad

The five way keypad on the top of the SI Series allowing functional and menu navigation

Discrete Inputs

Lines into the SI Series that allow remote control of certain parameters

Discrete Outputs

Lines out of the SI Series that can be used to drive external loads. These can be set either as NPN or PNP configuration

Serial Interface

Either ASCII protocols (as defined in this manual) or Modbus RTU or Modbus ASCII. The serial bus can be configured as either RS232 or RS485 signal levels.

Digital Probe

A standard Solartron product that can be connected to the SI200 to form a two channel measurement device, or to the SI400 to make up to a four channel device.

Connection Unit

SI100: Base Module to allow the unit to be mounted on a DIN rail or screwed down to a mounting plate

SI200: A 3 way connector housed in a case on the base of the SI200, which allows a Digital probe to be connected to form a two channel product

SI400: A 3 way connector housed in a case on the base of the SI400, which allows three Digital probes to be connected to form a four channel product

6 MECHANICAL INSTALLATION

The SI Series products are not a sealed instrument and care should be taken when installing the instrument in environments where contamination can come into contact with the unit.

It is advisable to protect the unit and if regular access to the keypad is required use a remote switch connected to the discrete inputs to perform the required user action.

7 ELECTRICAL INSTALLATION

Note. The Orbit ACS Series of products are not sealed instruments and care should be taken when installing in environments where contamination can come into contact with the unit.

7.1 PC SYSTEM REQUIREMENTS

7.1.1 PC Hardware Requirements

- Personal computer with a processor running at 1GHz or faster with 2GB or more RAM.
- An available USB port.

7.1.2 PC Software Requirements

- Microsoft Windows® operating system (Windows® XP, or later)
- Solartron Orbit3 Support Pack For Windows.

7.2 INSTALLING THE ORBIT3 SUPPORT PACK FOR WINDOWS® SOFTWARE

Important! Please ensure that you have Administrative access rights for installing this software. Before you can use the Orbit ACS configurator utility, you must have the Orbit3 Support Pack for Windows® software installed on your computer; this is freely available from the Solartron website (<http://www.solartronmetrology.com>).

This will install the latest version of this manual, the Orbit ACS configurator utility and Orbit3 Updater that are required for using Orbit ACS products.

7.3 CONNECTIONS

This section describes how to connect the unit

- 12 Input 4
- 11 Input 3
- 10 Input 2
- 9 Input 1
- 8 External Supply for Outputs
- 7 Output 3
- 6 Output 2
- 5 Output 1
- 4 Serial Connection: RS232Rx or RS485 B
- 3 Serial Connection: RS232Tx or RS485 A
- 2 0V Power
- 1 18-32V DC Power

Operating Currents (mA) (nominal)		
	SI100 or SI200	SI200 + 1 DP
18V	60	80
24V	52	68
32V	50	62

Mini-USB Port for configuration via a PC and firmware updates

MAINS TO +24V DC POWER BLOCK (ACCESSORY)

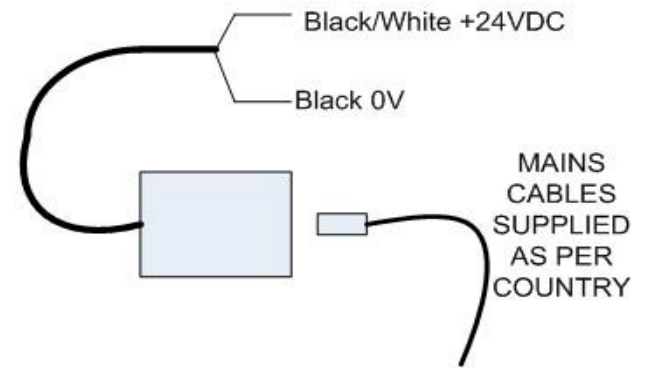

A mating connector is supplied with each unit (This can be removed for wiring)
 Additional connectors can be purchased from Solartron Metrology
 OR Phoenix Contact Part Number MC1,5/12-ST-3,5
 OR Camden Part Number CTB92HD/12



NB. For RS232 connection, the 0V connection must be connected to the RS232 GND

DO NOT CONNECT ANY POWER SOURCES TO THE 9 WAY D DYPE OF THE SI200/SI400

7.4 GROUNDING, CABLES AND POWER SUPPLIES

It is advisable to provide a good ground point for the SI Series.

The SI100 is a standalone unit, normally the probe would be connected to ground, there is no specific need to ground the electronics module.



The SI200/SI400 can be connected to a Solartron Digital Probe using the nine way connector, if both the SI200/SI400 and the Digital Probe(s) are mounted on a DIN rail additional grounding can be performed using the grounding bracket (see diagram)

The digital probe has two indication LEDs. The blue led is on when the SI200/SI400 and digital probe(s) are communicating. The red led will flash if there is not enough power reaching it. This may indicate a fault with the SI200/SI400.

If the unit is the first or last device in a multi-drop RS485 network, to meet the termination requirements we recommend the fitting of a 120Ω resistor across pins 3 and 4 of the 12 way connector.

7.5 NOISY ELECTRICAL ENVIRONMENTS

This section discusses the type of installation required depending on the electrical environment.

7.5.1 Residential, Commercial and Light Industrial Environments

Typically, this will be an office, laboratory or industrial environment where there is no equipment likely to produce high levels of electrical interference, such as welders or machine tools.

Connections may be made using twisted, unscreened wire. This is a cost effective option and will give good performance in this environment.

Standard equipment wire such as 7/0.2 (24 AWG) can be twisted together as required. Standard data cable such as generic CAT5 UTP will also give good performance.

7.5.2 Industrial Environments

Typically, this will be an industrial environment where there is equipment likely to produce high levels of electrical interference, such as welders, machine tools, cutting and stamping machines.

Connections should be made using screened cable. Braided or foil screened cables may be used. The cable screen should be connected to the Orbit ACS unit at the 0V connection.

In some particularly noisy environments it may be necessary to add ferrite filter components on power and/or data cables.

When selecting the type of wire or cable to be used, consider the following parameters:

Screening. • Conductor size (resistance). Mechanical aspects such as flexibility and robustness.

This is not a complete list. Installations may require other special cable characteristics.

8 CONFIGURATOR APPLICATION

For easy setup of multiple Orbit ACS units, the Orbit ACS configurator utility for Windows based PCs is available, included with the Orbit3 Support Pack for Windows.

The unit must be connected to the PC via the USB Mini B port on the rear of the unit and then powered in the normal way, as it is not powered via the USB lead.

The configurator mimics the settings available on the unit itself and enables the user to save a unit's configuration and then load the same configuration onto other units.

The configurator has multiple 'tabs' (see below). Each will display and allow adjustment of their respective settings.

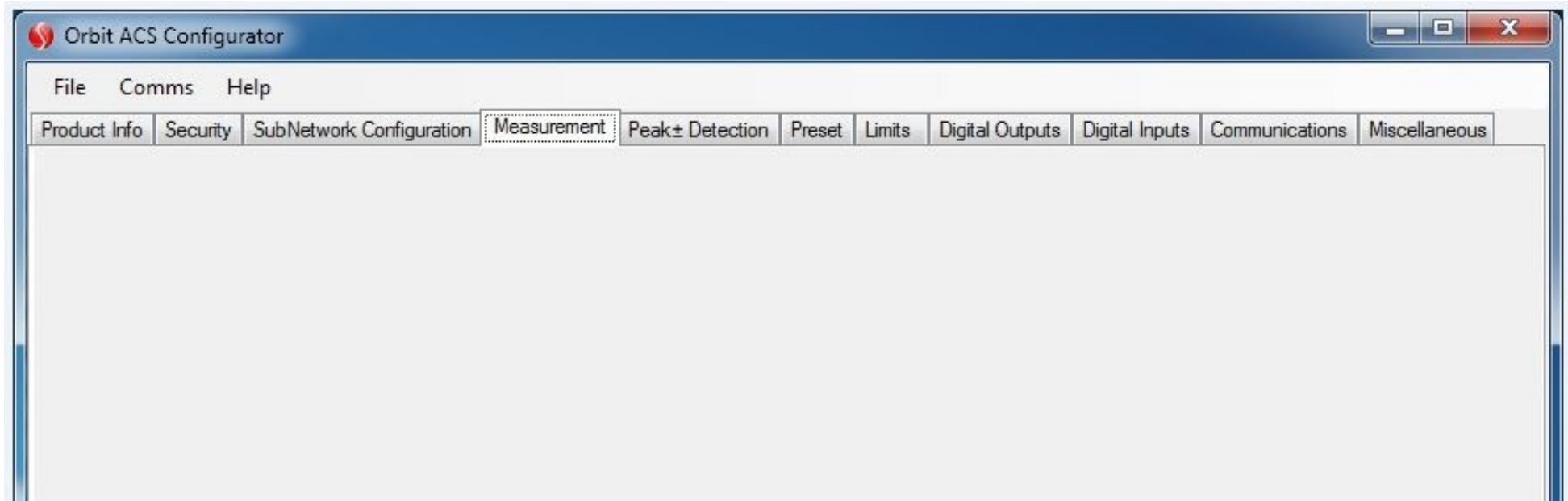

9 FUNCTIONS AND DISPLAYS

This section describes the operation of the SI100 and SI200, section 20 (SI400 Appendix) should be referred to for differences between these products and the operation of the SI400 unit.

9.1 SI100 AND SI200 DISPLAYS

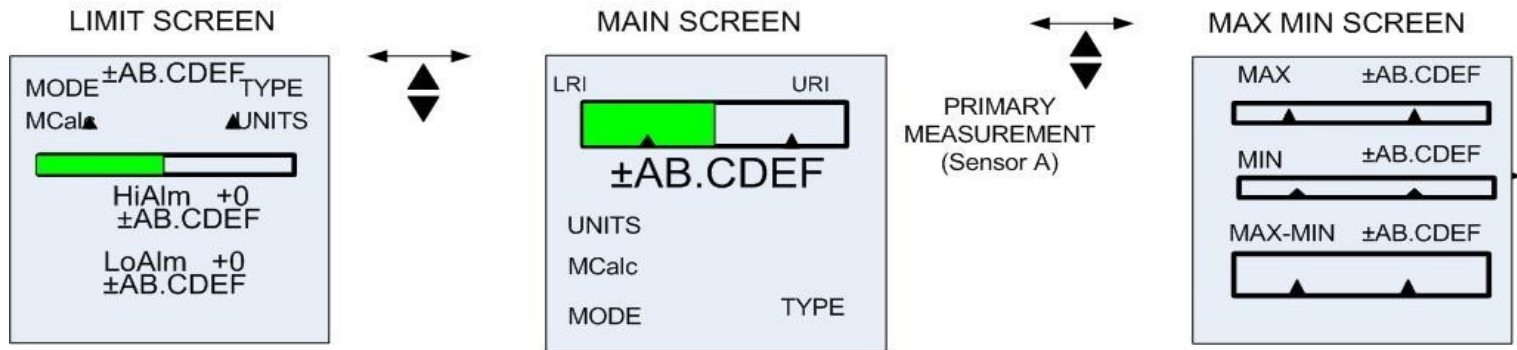

SI100 & SI200	TYPE	MODE	UNITS	Mcalc
	TRACK	ABS	mm	A
	PEAK+	ZERO	inches	MAXA-MINA
	PEAK-	PRESET	mils	
SI200				B, A+B, A-B (A+B)/2, (A-B)/2 MAXB-MINB

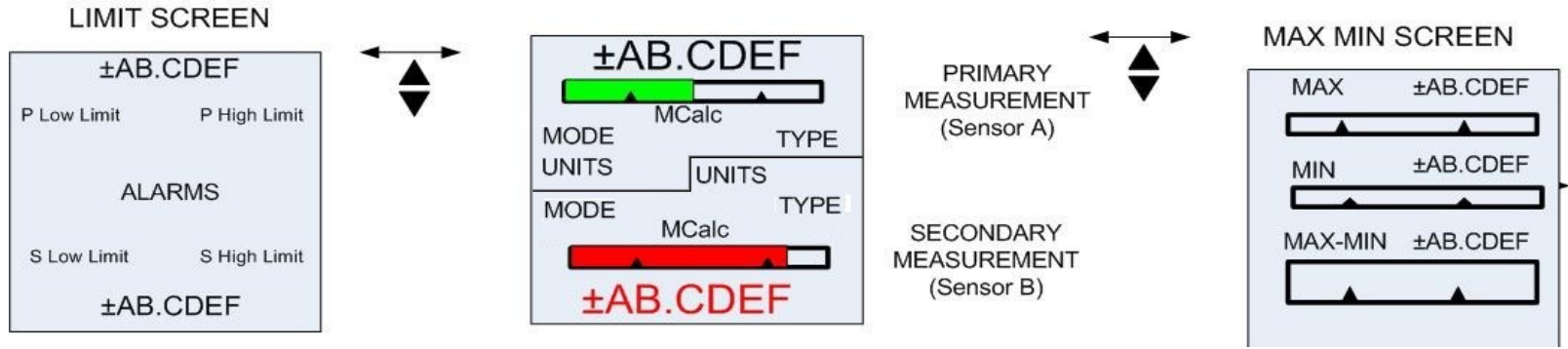

9.2 SI100 AND SI200 ACTIONS

The SI100 and SI200 can perform actions either via the keypad or the 4 discrete inputs

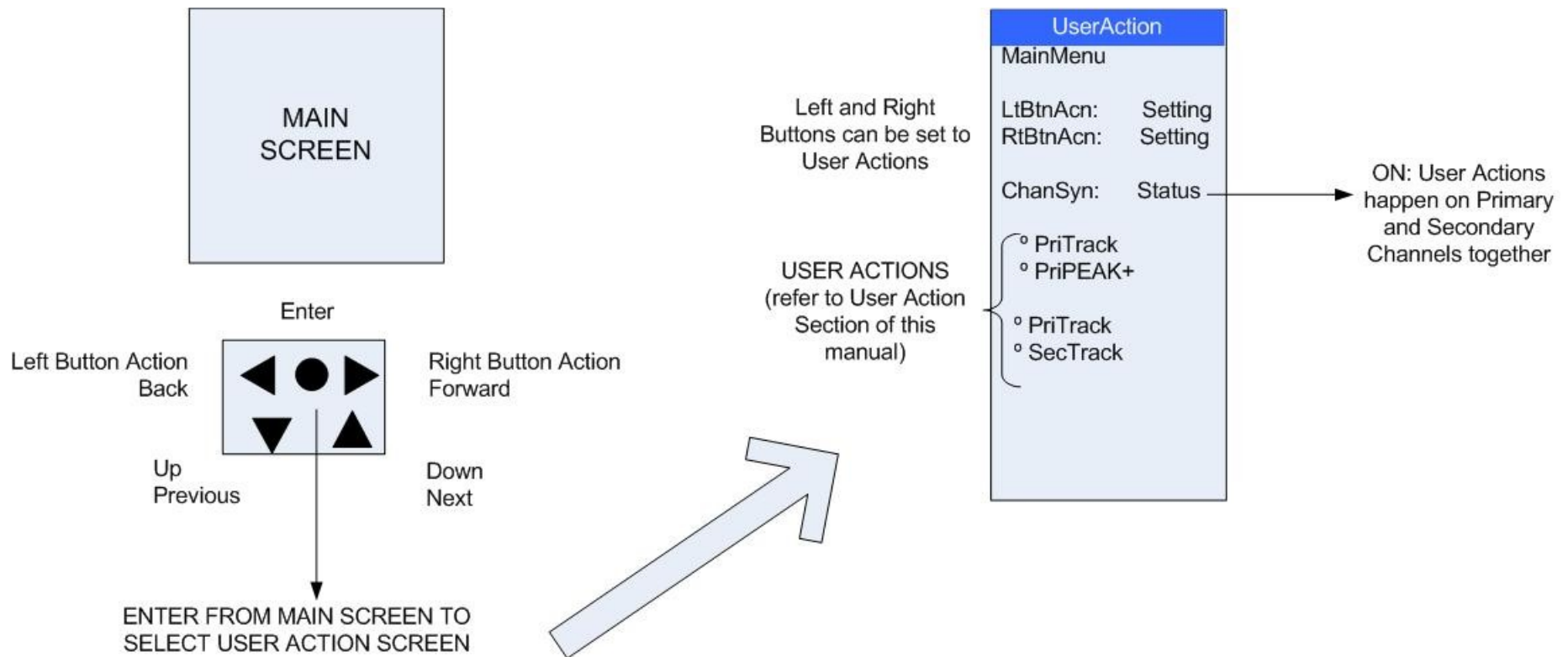

The Actions are described in the following table

ACTION	DESCRIPTION	COMMENT	SI100	SI200
PriTrack	Sets the Primary Channel into TRACK type measurement	The display follows the probe movement in both directions	●	●

PriPeak+	Sets the Primary Channel into PEAK+ type measurement	The display shows the most positive value	☺	☺
PriPeak-	Sets the Primary Channel into PEAK- type measurement.	The display shows the most negative value	☹	☹
PriPKRST	RESETS the Primary Channel to the current probe reading when in PEAK+ or PEAK- type measurement.	The display shows the current probe reading immediately following the PriPKRST action and then operates as either PEAK+ or PEAK- depending on which measurement type is set.	☺	☺
PriABS	Sets the Primary Channel to ABSOLUTE Mode directly displays the probe measurement. (no zero or offset)		☹	☹
PriZERO	Sets the Primary Channel to ZERO Mode directly displays the probe measurement.	The display and value of the serial output is set to ZERO. All further measurements are with respect to this new zero. (Example: If the measuring range is 0 to 10mm and the absolute reading is 4mm, on PriZERO action the display and value of the serial output will be zero. Then if the probe is moved to it to an absolute position of 6mm the display and serial output will indicate +2mm)	☺	☺
PriPreset	Sets the Primary Channel on SI200 to PRESET Mode directly displays the probe measurement.	The display and value of the serial output is set to the PRESET VALUE for Primary Channel. All further measurements are with respect to this new value. (Example: If the measuring range is 0 to 10m, the absolute reading is 4mm, and the Primary Channel Preset is 20 then following a PriPRESET action the display and value of the serial output will be 20mm. Then if the probe is moved to it to an absolute position of 6mm the display and serial output will indicate +22mm)	☺	☺
PAMxRST	If the Primary display is MaxA-MinA resets the Maximum A value to zero		☹	☹
PAMnRST	If the Primary display is MaxA-MinA resets the Minimum A value to 0		☹	☹
PMxMnRST	If the Primary display is MaxA-MinA resets this value to zero or the PRESET value		☹	☹
PRINT	Sends the measurement and other data out	Note the serial communications must be set to match the receiving	☺	☺

	via the serial communications link	device		
PBMxRST	If the Primary display is MaxB-MinB resets the Maximum B value to zero		☺	☺
PBMnRST	If the Primary display is MaxB-MinB resets the Minimum A value to 0		☺	☺
PMxMnRST	If the Primary display is MaxB-MinB resets this value to zero or the PRESET value		☺	☺
SecTrack	Sets the Secondary Channel on SI200 into TRACK type measurement	The display follows the probe movement in both directions	☺	☺
SecPeak+	Sets the Secondary Channel on SI200 into PEAK+ type. measurement	The display shows the most positive value	☺	☺
SecPeak-	Sets the Secondary Channel on SI200 into PEAK- mode	The display shows the most negative value		☺
SecPKRST	RESETS the Secondary Channel to the current probe reading when in PEAK+ or PEAK- type measurement.	The display shows the current probe reading immediately following the PKRST action and then operates as either PEAK+ or PEAK- depending on which measurement type is set.		☺
SecABS	Sets the Secondary Channel on SI200 to ABSOLUTE Mode directly displays the probe measurement. (no zero or offset)	See PriABS		☺
SecZERO	Sets the Secondary Channel on SI200 to ZERO Mode directly displays the probe measurement.	See PriZERO		☺
SecPreset	Sets the Secondary Channel on SI200 to PRESET Mode directly displays the probe measurement.	See PriPRESET (note the Primary and Secondary Preset values can be different)		☺
SAMxRST	If the Secondary display is MaxA-MinA resets the Maximum A value to zero			☺
SAMnRST	If the Secondary display is MaxA-MinA resets the Minimum A value to 0			☺
SMxMnRST	If the Secondary display is MaxA-MinA resets this value to zero or the PRESET value			☺
SBMxRST	If the Secondary display is MaxB-MinB resets			☺

	the Maximum B value to zero			
SBMnRST	If the Secondary display is MaxB-MinB resets the Minimum A value to 0			⊕
SMxMnRST	If the Secondary display is MaxB-MinB resets this value to zero or the PRESET value			⊕

9.3 MENU SCREENS

The MENU Screens are used to set up the SI100 and SI200 operating modes.

Some of the menu screens require numbers to be entered.

Use the ◀ and ▶ to move to the digit required to be adjusted and use ▲ to increment and ▼ to decremented.

The number will be increased or decreased by the magnitude of the digit selected, see below

		1000	100	10	1		1/10	1/100	1/1000	1/10000	1/100000	1/1000000
Min	+/-	1000	100	10	1		0.1	0.01	0.001	0.0001	0.00001	0.000001
Max	+/-	9999	999	90	9		0.9	0.09	0.009	0.0009	0.00009	0.000009

Examples

+	2	•	1	2	3	4						
▼												
+	1	•	1	2	3	4					2.1234	- 1 = 1.1234
▼												
+	0	•	1	2	3	4					1.1234	- 1 = 0.1234
▼												
-	0	•	8	7	6	6					0.1234	- 1 = -0.8766
▲												
+	9	•	1	2	3	4					-0.877	+ 10 = 9.1234
▼												
+	9	•	0	2	3	4					9.1234	- 0.1 = 9.0234
▼												
+	8	•	9	2	3	4					9.0234	- 0.1 = 8.9234

TIP: Set the most significant digits first.

9.3.1 Top Level Menu

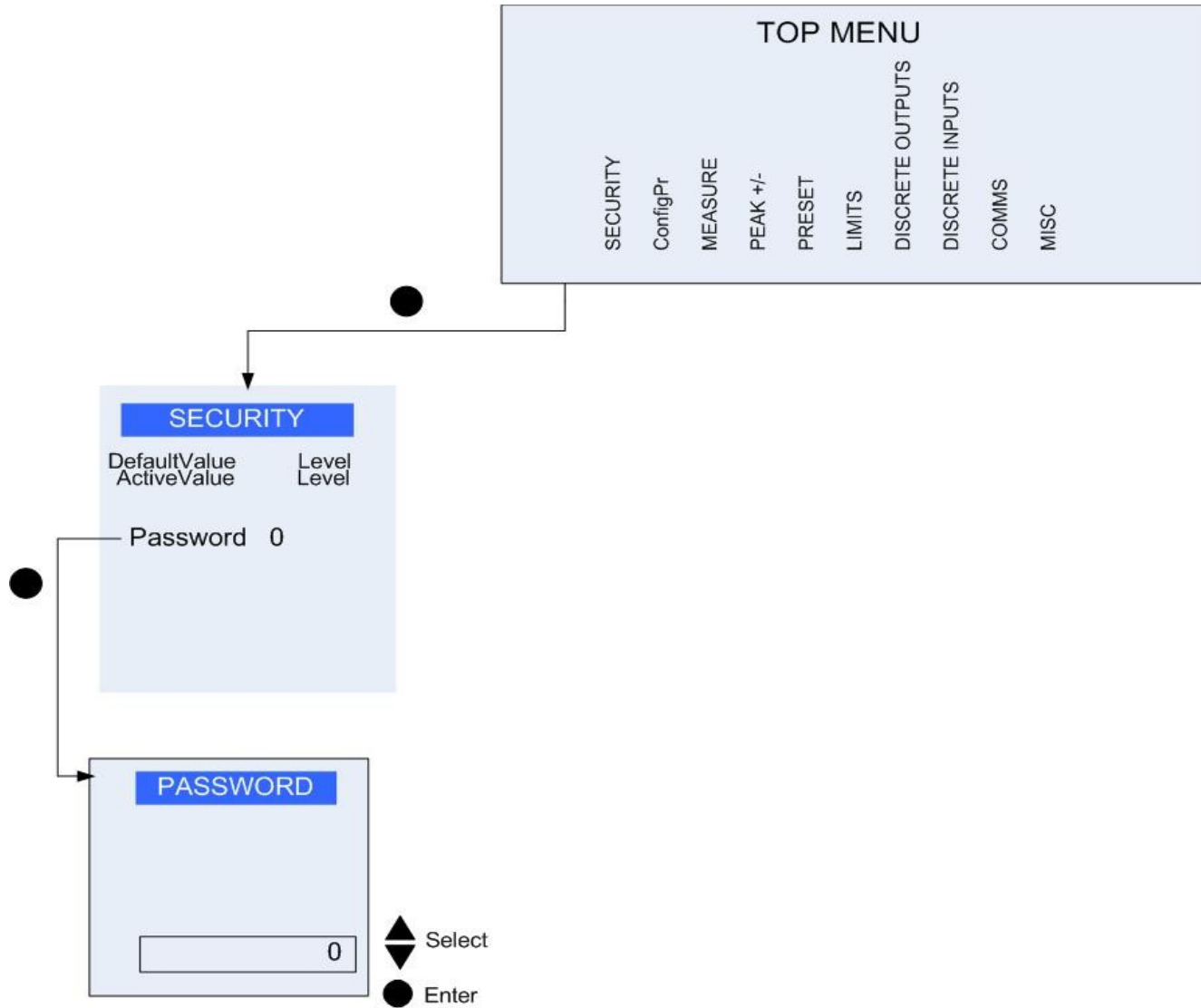

9.3.2 Configure Probe(s)

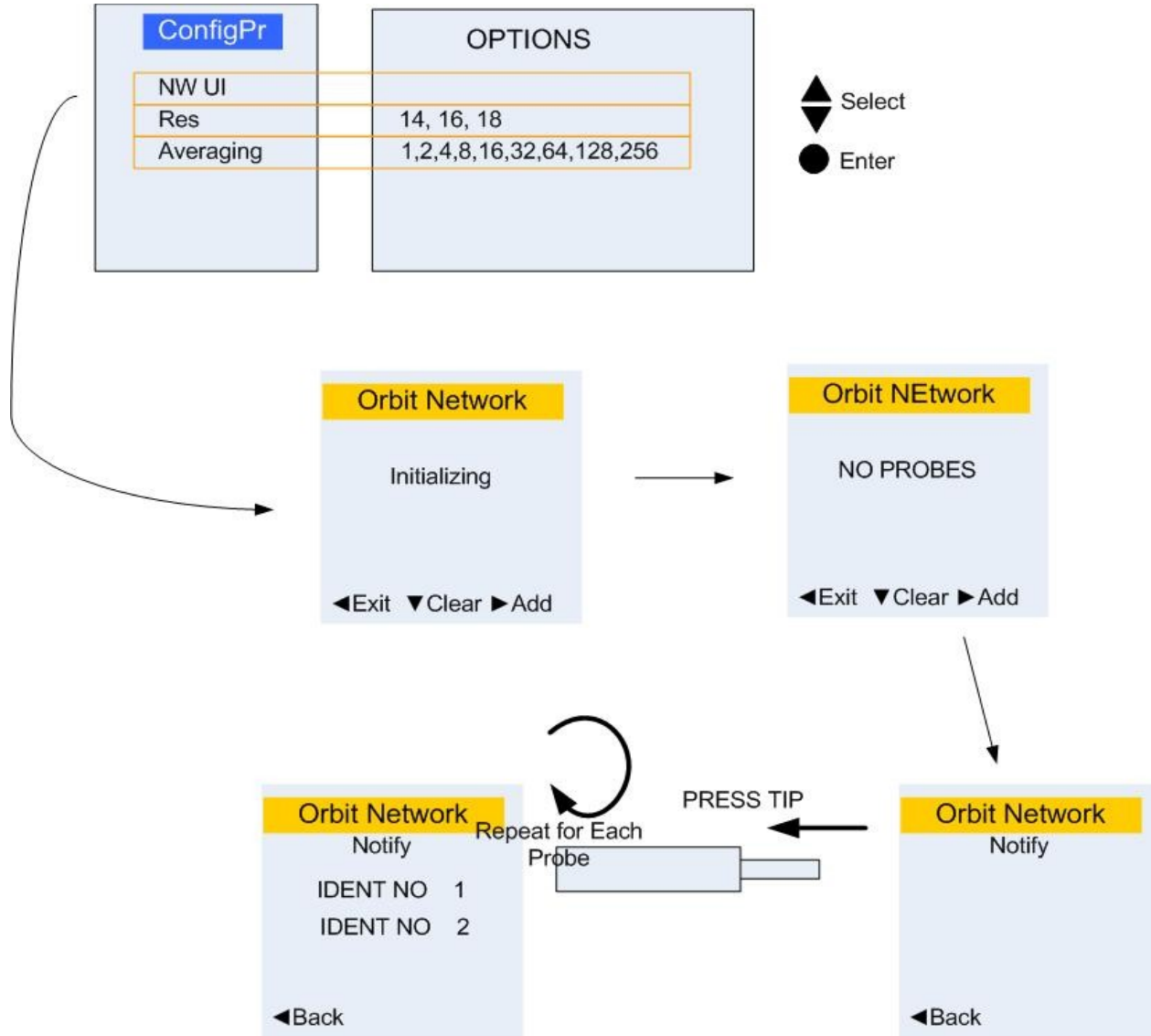

As well as the menu items shown in the above diagram, the ConfigProbe(s) menu also includes the 'Units' parameter. This defines the Units Of Measure input readings from modules are converted to. Can be configured for MM, Inch or Mil. Note: Only 'MM' type input modules are converted, AIMS (input types of Volts, Current or Temperature) will not be converted.

9.3.3 Probe Sub-menus

Each probe has a sub-menu containing information about its serial number, module type, status, scale etc. Some have extra information and/or settings.

All module sub menu's include parameters for Scale and Offset as well as ReScale and ReOffset. Scale and Offset are read only and report the scale / offset of the module (4-20mA AIM for instance would provide an offset of 4mA and a scale of 16mA).

The 'ReScale' and 'ReOffset' parameters can be used to adjust the reading to real-world values. For example the above AIM providing 4-20mA could be modified to produce 0-100% by setting the ReOffset parameter to 0 and the ReScale parameter to 100.

Note1: Whenever a module is added, the ReScale and ReOffset parameters are reset to the module Scale and Offset.

Note2: LT modules have an unknown scale and will default to a scale of zero when added – the ReScale parameter therefore needs to be configured before an LT type module can be used. The ACS will provide an on-screen warning message about this.

9.3.3.1 LTH Lasers

The LTH Lasers also include a setting for 'Level Cut Time' (parameter: LsrLvICT). This can be configured from 0.1mS to 1 second. See the Orbit LTH user leaflet for application details.

The Laser sampling rate is displayed in its sub-menu, but is fixed at 4kHz. For increased filtering, use the 'Averaging' setting in the ConfigPR menu.

9.3.3.2 Modules supported externally only

Analogue Input Modules (AIM) and Linear Encoders (LE) modules are supported by the ACS, however they can only be included as external modules on the network, the ACS is not available with an AIM or LE 'built-in'.

9.3.3.3 Unsupported modules

The ACS does not support the WCM, DIOM, DIM, and EIM type modules, ether externally or internally.

9.3.4 Measure Menu

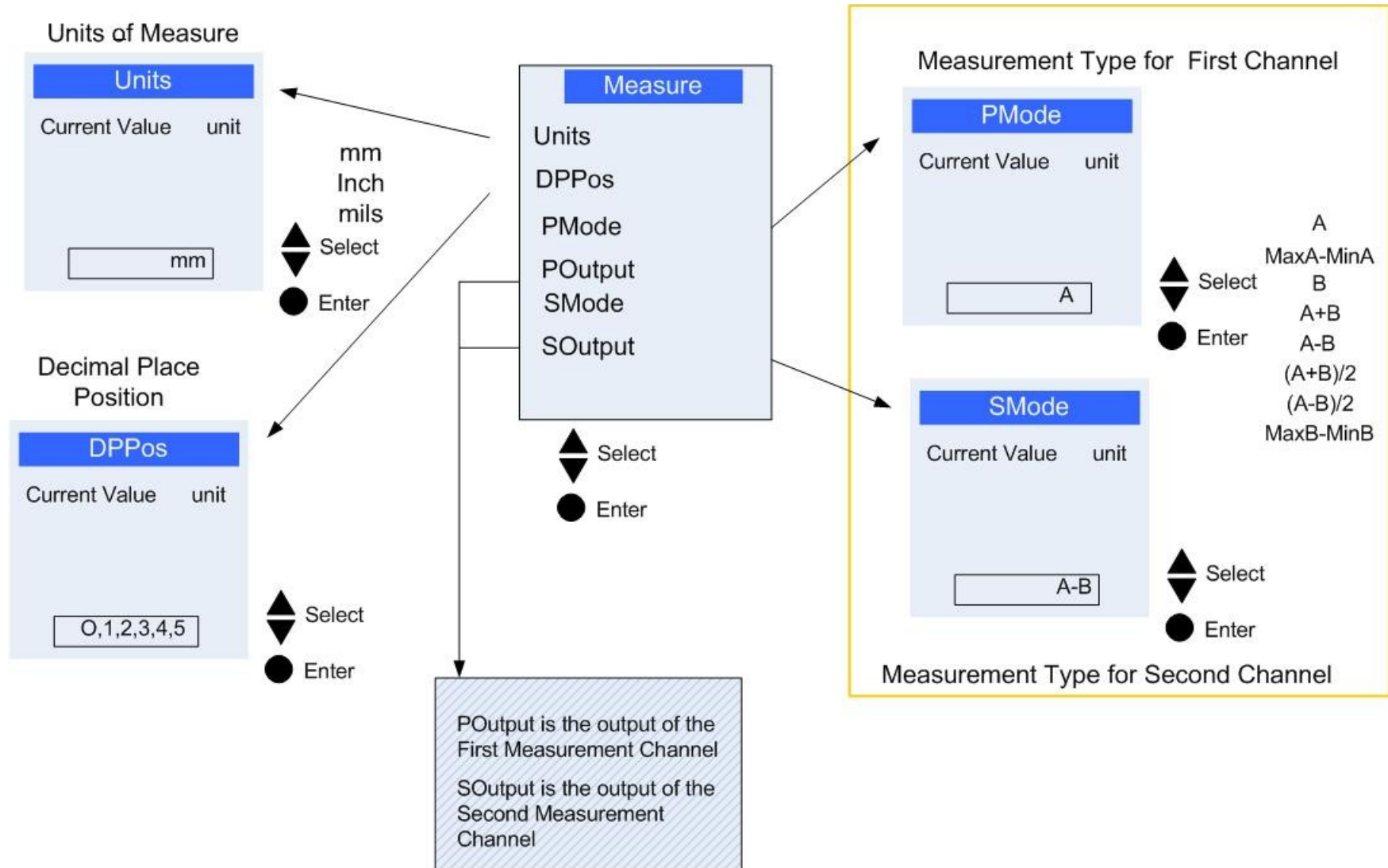

Note: As of firmware Version 1.49, each 'Channel' has it's own UOM (Units of Measure) parameter and it is the configured string that is

displayed along side the relevant channel on the display.

To maintain backward compatibility, a Channel UOM configured to “SysUnits” (which is the default setting) will revert to displaying the units as indicated by the original SysUnits parameter (MM, Inch or Mil).

This facility allows for computed channels or rescaled modules to be shown with real-world Units Of Measurement.

9.3.5 Peak, Preset, Limits and Misc Menu

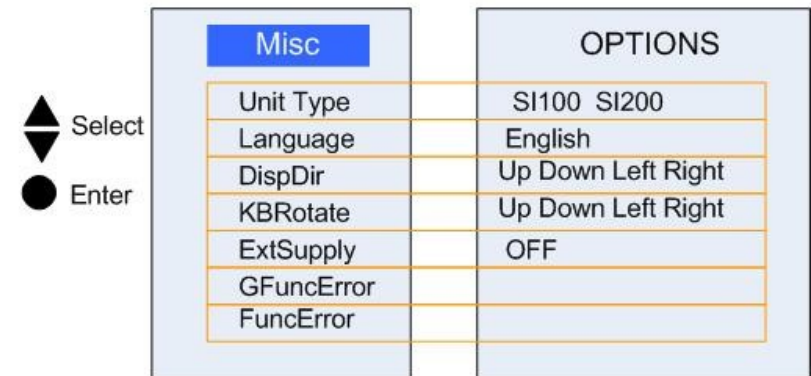
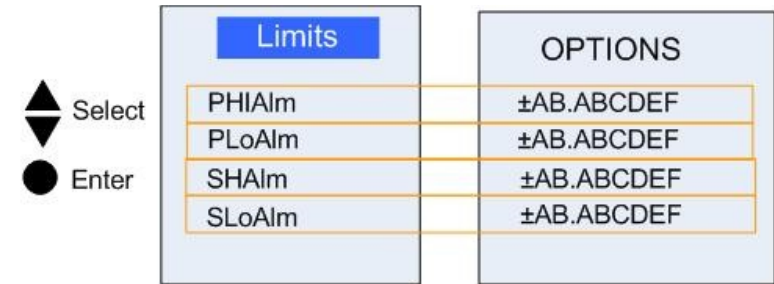
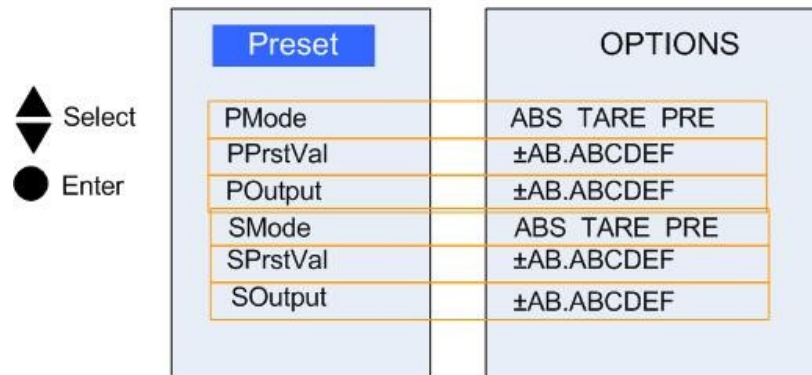
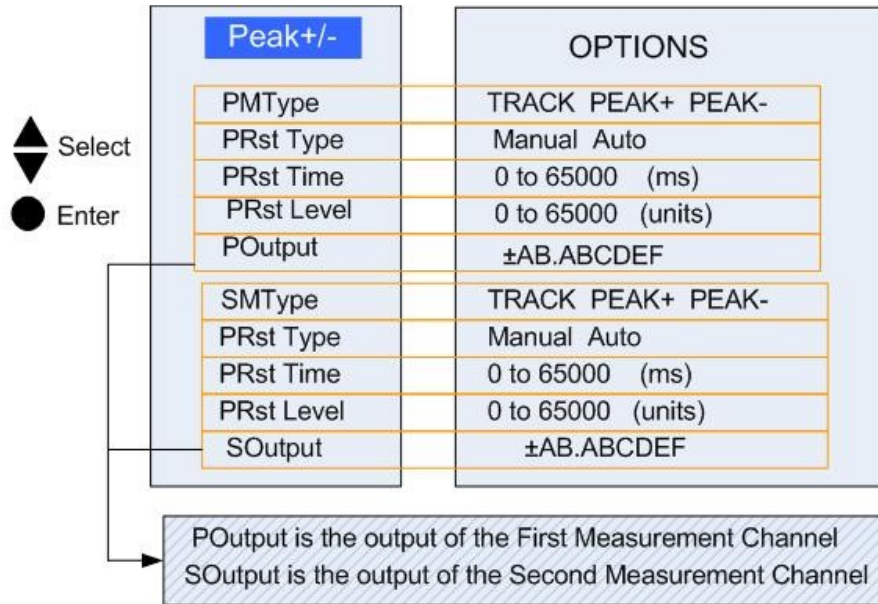

9.3.6 Output, Input and Communications Menu

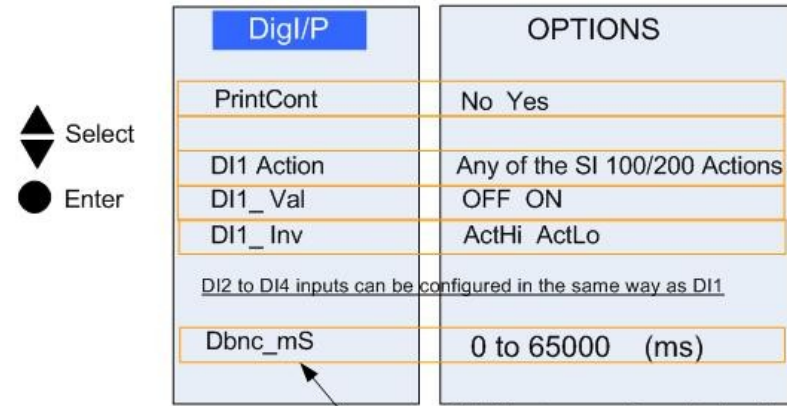
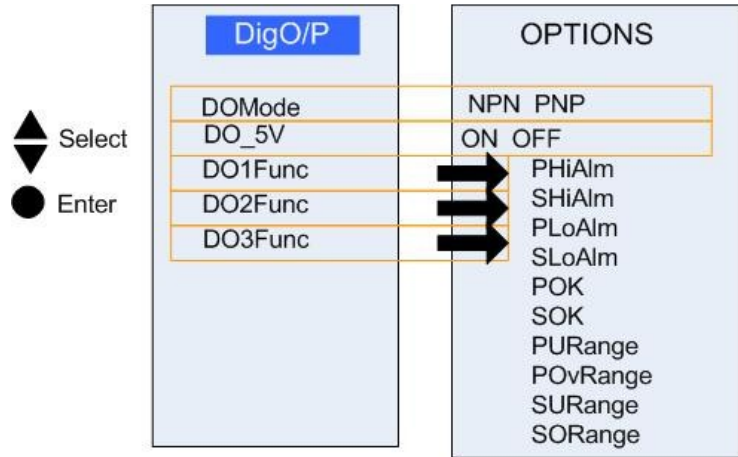

Digital Inputs are configured to be either active Hi or Active Lo, The Digital value fields show the current input status (Example if DI1 active Lo and it is at 0V status = on)

Input Debounce Time is the delay between an action event and the event happening.

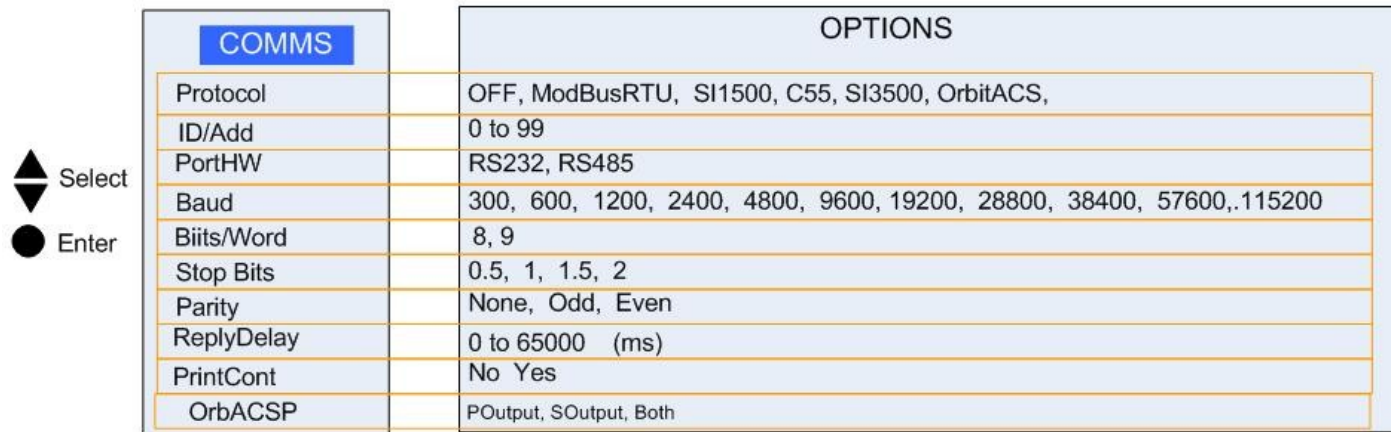

9.4 COMMON ERROR MESSAGES & STATUS CODES

9.4.1 Display Error messages

Error code		Description	Action
Internal Error	1	Hardware fault 1	Recycle power if error still occurs unit must be returned for repair
	2	Hardware fault 2	
	3	Hardware fault 3	
Node Error	1	Network Error 1	The Orbit Module on the network can no longer be found (at position 1, 2 3 or 4). The module has been changed and needs to be re-notified or some other problem has occurred. Cycle power and then reconfigure the network.
	2	Network Error 2	
	3	Network Error 3	
	4	Network Error 4	
Probe Error	1	Probe Error 1	An in line connector type probe has failed or been swapped by the wrong type. Check the probe type matches the module type. Correct as required. Cycle power and re-configure network.
	2	Probe Error 2	
	3	Probe Error 3	
	4	Probe Error 4	

9.4.2 Detachable Probes Error Messages

If a compatible probe is not fitted at startup or is dis-connected during use, a pop-up message is displayed stating ' Internal probe detached or incompatible'. This message is also displayed if a compatible probe is not connected and an attempt to add a probe is made.

External modules do not generate this error message, however the Reading Status parameter will indicate the appropriate values.

9.4.3 Modbus Errors

When using an external device to read probes using Modbus communications, the relevant reading status parameter should also be read to confirm the validity of the reading.

ReadingStatus Value	Displayed Value	Meaning
0	OK	Reading Valid
18	URangeA	Under Range for Channel / Module
19	ORangeA	Over Range for Channel / Module
246	246	Incompatible probe connected
247	247	No probe connected

With the ASCII based serial communications, the 'Limit' character indicates the probe's error status.

10 SECURITY LEVELS

The SI100 and SI200 products have functions that can be set using different levels of security passwords. The default level on power on is level 0. The table below indicates the functions available at different security settings. This feature allows the SI100/200 to be set up by a technician and blocks an operator from changing any parameter settings.

The unit is shipped with the following passwords which may be reset by the user.

NOTE: if the password is lost/forgotten there is a utility available from your supplier to reset the unit to Factory defaults.

level	Password	Description	Functions
0	No password	Normal Operation	Access Action Screen Access MENU (Read Only) Operator cannot change set up configurations
1	1234	Future Options	
2	2345	Future Options	
3	3456	Future Options	
4	4567	Configuration 1	Main Set Up Mode used to change parameters
5	5678	Future Options	
6	6789	Future Options	
7	Not Published	Solartron Only	

11 OUTPUTS

The SI100 and SI200 have three digital outputs. These can be connected in various ways and either powered from an internal 5V supply or an external supply. The output configurations are shown below, the output type is set in the Digital Output MENU

Pull Down with External Supply (NPN)

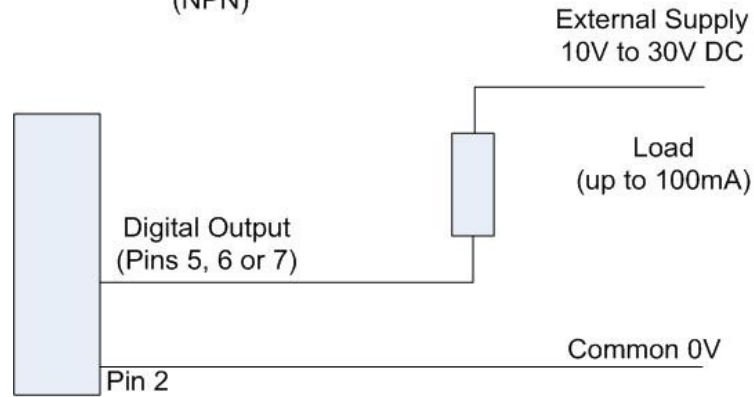

Pull Down Logic 5V

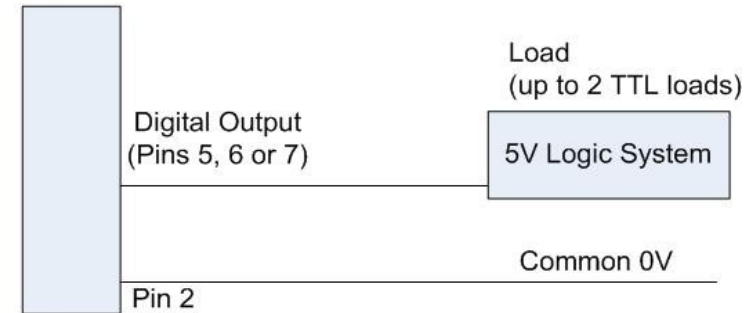

Pull Up with External Supply (PNP)

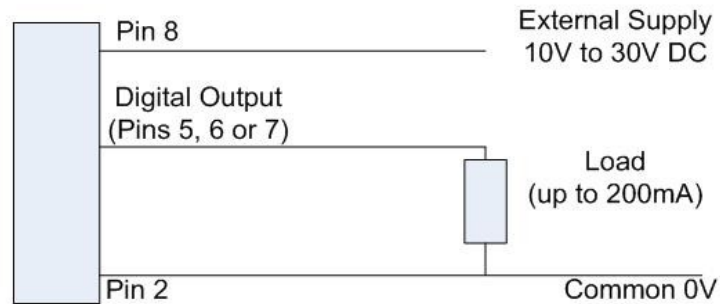

The digital outputs of the SI100 may be configured to reflect any of the following states: -

- Primary Channel High Alarm
- Primary Channel Low Alarm
- No Alarms
- Primary Range Error (either under or over)
- Module 1 Under Range
- Module 1 Over Range

The digital outputs of the SI200 may be configured to reflect any of the following states: -

- Primary Channel High Alarm
- Primary Channel Low Alarm
- No Alarms on Primary Channel
- Primary Range Error (either under or over)
- Module 1 Under Range
- Module 1 Over Range
- Secondary Channel High Alarm
- Secondary Channel Low Alarm
- No Alarms on Secondary Channel
- Secondary Channel Range Error (either under or over)
- Module 2 Under Range
- Module 2 Over Range

12 DIGITAL INPUTS

12.1.1 Digital Inputs Configuration Options

The SI100 and 200 has four digital inputs which may be connected as shown. These can be allocated to perform any of the SI100 or SI200 actions as described in section 9.2 - Actions.

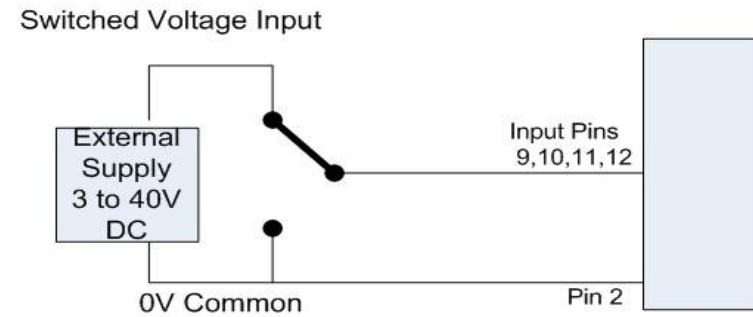
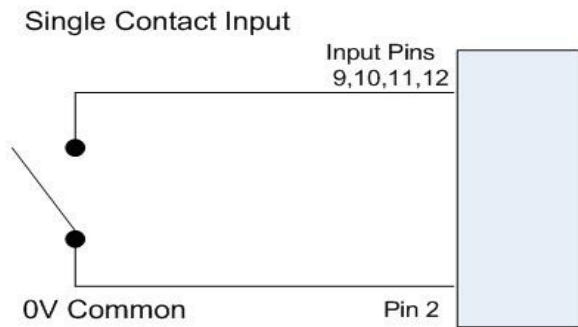

Logic Input

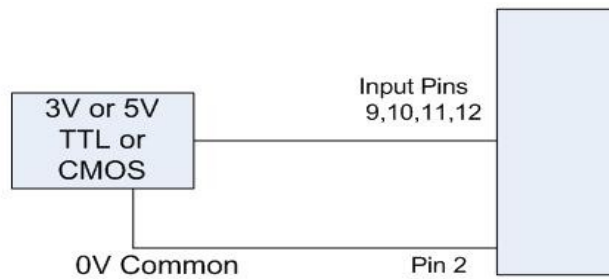

Note
Input pins can be set active high or active low

12.1.2 Discrete Print Input

The discrete print input works in the same way as the print key. However the Print action is different depending if the orbit ACS is in Single Print or Continuous Print Mode

SINGLE PRINT MODE (one print message sent each time the print input goes active)

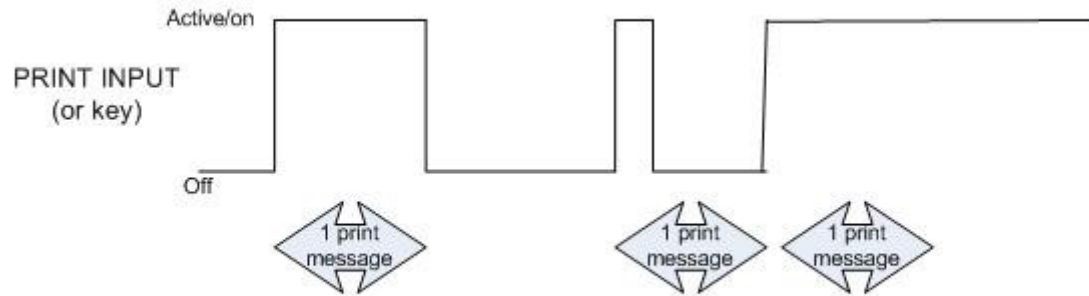

CONTINUOUS PRINT MODE (print messages sent continually while print input active)

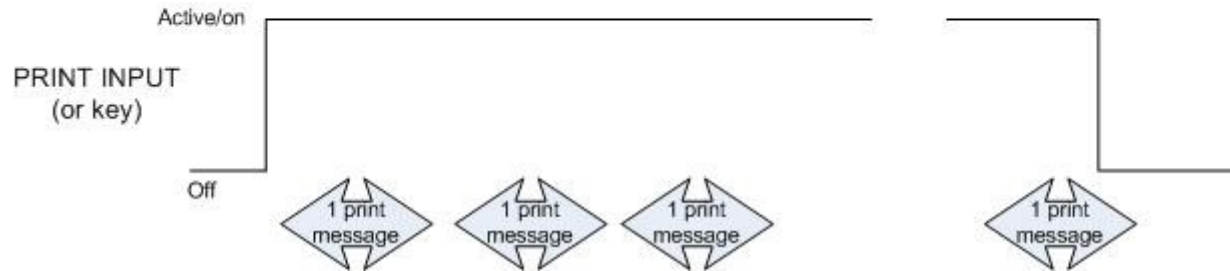

Note a delay can be set between print outputs using the COMMS menu (ReplyDelay).

13 TIMING AND MEASUREMENT INFORMATION

Parameter	Update rate	Comment
Measurement Reading Rate	5 mS	10mS for SI400
Digital Output Update	5 mS from measurement	10mS for SI400
Response to Digital Input	5 mS	10mS for SI400
Probe Reading Rate	256uS	The probe connected to the ACS unit and any external digital probes are updated at this rate Averaging is applied at this rate. i.e. 16 x averaging will complete every 4.096mS
Probe Averaging	1,2,4,8,16,32,64,128,256 cycles	Averaging is applied at this rate. i.e. 16 x averaging will complete every 4.096mS
Measurement Bandwidth (electronics)	4,8,16,32,64,128,256, 512 Hz	Measurement bandwidth directly related to the Probe averaging value 1 – 512Hz 256 - 4Hz
Resolution	14 bits 16 bits default 18 bits	To calculate the resolution for a probe $1 \text{ bit} = \text{Probe Range (microns)} / 2^{\text{resolution}}$

14 SERIAL COMMUNICATIONS (GENERAL)

The SI100 and SI200 has several options for Serial Communications.

14.1 RS232 AND RS485 SIGNAL LEVELS

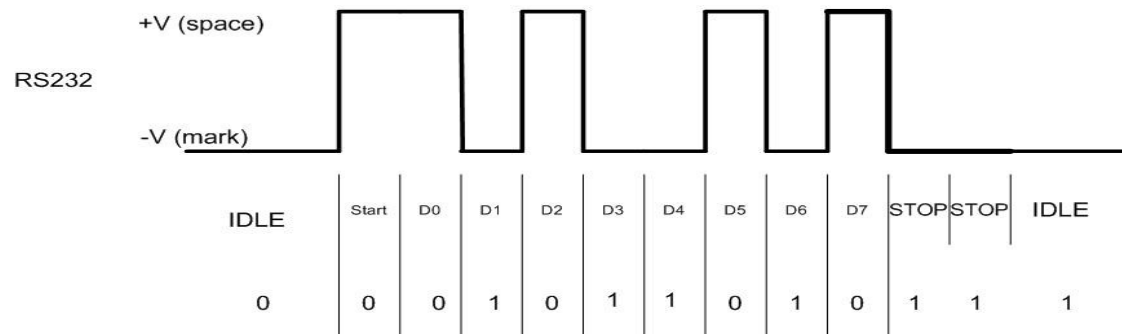

Orbit ACS RS232 Specification

EIA/TIA-232 specification

Input (Rx) Voltage Range $\pm 25V$
Output (Tx) Voltage range $\pm 13V$

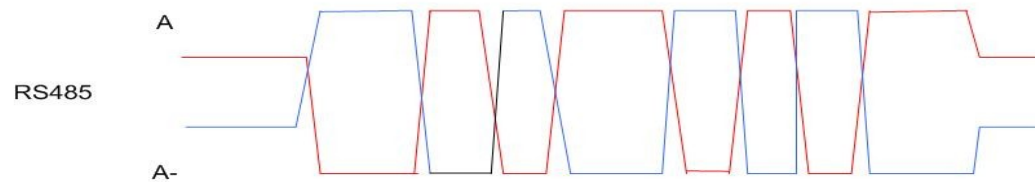

Orbit ACS RS285 Specification

EIA RS-485 Compliant
Minimum Differential Input voltage 200 mV
Max Output/Input Voltage -9V to +14V

14.2 TYPICAL RS232 WIRING

Most Computers use a 9 way D Type which uses PIN2 Rx, PIN3 Tx and Pin5 GND

To connect the SI100 RS232 use the table below

SI100 SI200	9 Way D Type
PIN3 (Tx)	PIN 2 (Rx)
PIN4 (Rx)	PIN 3 (Tx)
PIN 2 (0V)	PIN 5 GND

Response to “^D” ASCII serial command returns Status of discrete Inputs and outputs

0	1	2	3	4	5	6	7	8	9	10	11	12	13	14	15	16	17
D	i	n	.	A	B	C	D		D	o	u	t	E	F	G	\r	\n

where A, B, C, D are logic levels for the discrete inputs: 1,2,3,4

and E, F, G are logic levels for the discrete outputs: 1,2,3

15.3 SI1500 COMPATIBILITY PROTOCOL

SI1500

Response to ">Rxx\r\n" ASCII serial command only
Where xx is the Device ID.

Command		Unit ID		Limits	Sign	READING Right aligned with DP set by precision, LH digits are '0'						Carriage Return	Line Feed	
0	1	2	3	4	5	6	7	8	9	10	11	12	13	14
<	R	x	x	<	+	X	X	.	X	X	X	X	\r	\n
				=	-	0	X	X	.	X	X	X		
				>		0	0	X	X	.	X	X		
						0	0	0	X	X	.	X		
						0	0	0	0	0	X	X		

Command		Unit ID		Limits	Sign	READING Right aligned with DP set by precision, LH digits are '0'						Carriage Return	Line Feed
0	1	2	3	4	5	6	7	8	9	10	11	12	13
<	R	X	X	<	+	0	0	X	X	X	X	\r	\n
				=	-								
				>									

There is an variation to the above.



Special case if number of DP is set to 0
i.e. one byte less for the reading

Read Alarm limits

Response to ">Sxx\r\n" ASCII serial command only

same packet length issue with no DPs set

Command		Unit ID		Sign	Upper LIMIT Always shown with 4 DPs						Comma	Sign	Lower LIMIT Always shown with 4 DPs						Carriage Return	Line Feed					
0	1	2	3	5	5	6	7	8	9	10	11	12	12	13	13	13	13	13	13	13	13	13	12	13	
<	S	X	X	+	X	X	.	X	X	X	X	,	+	X	X	.	X	X	X	X	X	X	\r	\n	

15.4 C55 COMPATIBILITY PROTOCOL

C55

Response to 'Print' key press or discrete 'Print' input

Note. The LineFeed & Carriage Return characters are reversed

Sign	READING Format is XXXX.XXXX with leading zeros replaced by spaces									Space	Space	UNITS				Limits	Line Feed	Carriage Return		
	0	1	2	3	4	5	6	7	8	9	10	11	12	13	14	15	16	17	18	19
+				X	.	X							m	m				<	\n	\r
-				X	.	X	X						i	n	c	h		=		
				X	.	X	X	X					m	i	l			>		
				X	.	X	X	X	X									!		
			X	X	.	X														
			X	X	.	X	X													
		X	X	X	.	X														
	X	X	X	.	X	X														

Example																				
Measurement =	1	2	.	2	3	4														
+				1	2	.	2	3	4			i	n	c	h		=	\n	\r	

Orbit ACS Implementation of C55

The Orbit ACS emulation provides proper mm, inch, mil conversions
The C55 always prints in 'mm'

Not supported by the emulation:

No "None" units
7 Data bits with No Parity

Extras

We allow the following extra Comms setup options

Baud Rates: 300, 600, 4800, 28800, 38400, 57600, 115200

Stop bits: 1.5, 2

We allow up to 4 DPs to be outputted, regardless of the number size

i.e. C55 only allows x.xxxx up to xxx.xx

we provide x.xxxx up to xxx.xxxx

15.5 ASCII CHARACTER SET

	0	1	2	3	4	5	6	7
0	NUL	DLE	space	0	@	P	`	p
1	SOH	DC1 XON	!	1	A	Q	a	q
2	STX	DC2	"	2	B	R	b	r
3	ETX	DC3 XOFF	#	3	C	S	c	s
4	EOT	DC4	\$	4	D	T	d	t
5	ENQ	NAK	%	5	E	U	e	u
6	ACK	SYN	&	6	F	V	f	v
7	BEL	ETB	'	7	G	W	g	w
8	BS	CAN	(8	H	X	h	x
9	HT	EM)	9	I	Y	i	y
A	LF	SUB	*	:	J	Z	j	z
B	VT	ESC	+	;	K	[k	{
C	FF	FS	,	<	L	\	l	
D	CR	GS	-	=	M]	m	}
E	SO	RS	.	>	N	^	n	~
F	SI	US	/	?	O	_	o	del

Example ASCII "A" is HEX 41

16 MODBUS BASED SERIAL COMMUNICATIONS PROTOCOL

16.1 INTRODUCTION

The SI series of products support the Modbus communications protocol. More information regarding the Modbus protocol can be found online at www.modbus.org, with the full specification downloadable here: - http://www.modbus.org/docs/Modbus_Application_Protocol_V1_1b.pdf

Modbus Communications can be performed over a number of hardware layers including RS232 (single point-to-point communications) and RS485 (multi-drop network communications).

The SI100 and SI200 are Modbus slaves. They can be given a Modbus address (set in comm menu). A Modbus master can read and write from the units to set parameters or read from parameters. The Modbus parameter table for the device family is detailed in [section 14.2.8](#).

The SI range supports Modbus RTU and Modbus ASCII . Modbus RTU uses raw binary data whereas Modbus ASCII uses the data encoded as ASCII. (RTU is the most widely used).

16.2 OVERVIEW OF MODBUS COMMUNICATIONS

16.2.1 Modbus Master/Slave

The Modbus protocol is a Master/Slave (or Client/Server) system, with a single 'Master' controlling a network of one or more 'Slaves'.

The Master unit controls all communications, so whether it needs to read from one slave unit (reading inputs), write to another (setting outputs/configuration), or transfer information from one unit to another, it does so with a command/response message pair.

16.2.2 Modbus Unit ID

Each Modbus message contains a Unit ID (address), the servers listen to the Modbus communications and if they hear a message containing their UnitID they accept this message and respond. The SI100 and SI200 can have their address set in the COMMS menu.

16.2.3 Parameters

Each Slave unit will have within its help structure or documentation a 'Parameter Map', which details all the Parameters that are available, the conditions they are constrained by (limits, read / write privileges etc) and the function of the Parameter.

Modbus 'Registers' are 16 bit registers; often within industrial applications these 16 bit registers are ganged together to represent 32 bit data and 64 bit data, as well as floating point type information and Strings. The details about the number of registers a 'Parameter' consumes should be clearly detailed within the unit's documentation.

It is, however dangerous to read the 16 bit registers that make up a more complex 'Parameter' individually with separate message, as there is no way of knowing if the data was updated in-between reads, resulting in a corrupted value once the complex 'Parameter' is re-constructed.

The SI Series of products protect against this issue and will not allow the individual registers of a more complex parameter to be read individually, they must all be read with a single 'Read Multiple Registers' type command.

An Integer type parameter (consisting of a single or multiple 16-bit registers), can also include information to several decimal places. This is indicated within the Parameter Map by way of an inferred decimal place position; a Parameter with a decimal place position defined as '0' has no decimal places included, a decimal place position of '3' for instance would mean three decimal places of accuracy are included in the integer value.

Please refer to the example below for how an Integer value can be interpreted with decimal place precision.

Integer Value	Decimal Place Position	Inferred value
123456789	0	123456789
123456789	1	12345678.9
123456789	2	1234567.89
123456789	3	123456.789
123456789	4	12345.6789
123456789	5	1234.56789
And	So	On

Parameters can also be 'signed' or 'unsigned'. However, Two's Compliment negative mathematics is always employed for signed values.

16.2.4 Master Command Messages

Each message the Master transmits onto the network will at least include a 'Node Address' (also often referred to as a 'Slave Address' or 'ID'), as well as a 'Function Code', a 'Parameter Address' and finally a 'Checksum'. As well as these variables certain commands may also include a 'Parameter Count' and 'Data'.

Once the Master has transmitted the message, it awaits a response from the relevant Slave on the network up to a time limit generally referred to as a Timeout.

The Master system should generally include a retry mechanism and suitable Timeout period for the type of Slave units on the network.

16.2.5 Slave Unit Responses

Each and every Slave type unit on the network receives every message transmitted onto the network, so it first checks the 'Node Address' part of the message, if it finds a match with it's own configured Slave/ID/Node address, it will then process the whole message by first checking the 'Checksum', which is a value used together with a known algorithm to verify the content of the message is uncorrupted and valid to process.

Once verified as a valid message, the Slave unit then performs the function required by the Function Code element of the message and fetches the data required (Read) or sets the appropriate output / carries out the function of that parameter.

It then formulates a response message in similar format, with its own Node address and function code as a confirmation the correct Node is responding, as well as any data that was required and a calculated checksum.

The only type of message that doesn't solicit a response is a 'Broadcast' type message, which is not generally recommended as no confirmation of receipt type message is provided. The table below describes the basic elements of a Modbus Message and what their function is: -

Message Element	Description
Node Address	This indicates the Node the message is intended for (Master Transmission), or from (Slave response).
Function Code	The Function to carry out, this can be Read, Read Many, Write and Write Many type commands.
Parameter Address	The address of the parameter to read from or write to.
Parameter Count	The number of parameters to read or write.
Data	The data used to read / write from / to parameters
Checksum	The verification value used to confirm message validity.

For more details regarding the specifics of the Modbus protocol, please refer to the specification documents mentioned in section 1.1.

16.2.6 Modbus Function Codes Supported by SI Products

Within the Modbus specification, there are a number of Function Codes, not all of which are implemented by the SI Series of products. The table below shows the full list of Modbus Function Codes together with the Function Codes supported by the SI series.

Function Code	Description	SI Supported
01 (0x01)	Read Coils (single digital 'bit')	X
02 (0x02)	Read Discrete Inputs	X
03 (0x03)	Read Holding Registers	✓
04 (0x04)	Read Input Registers	✓
05 (0x05)	Write Single Coil	X
06 (0x06)	Write Single Register	✓
07 (0x07)	Read Exception Status	X
08 (0x08)	Diagnostics	X
11 (0x0B)	Get Comm Event Counter	X
12 (0x0C)	Get Comm Event Log	X
15 (0x0F)	Write Multiple Coils	X
16 (0x10)	Write Multiple registers	✓
17 (0x11)	Report Slave ID	X
20 (0x14)	Read File Record	X
21 (0x15)	Write File Record	X
22 (0x16)	Mask Write Register	X
23 (0x17)	Read/Write Multiple registers	X
24 (0x18)	Read FIFO Queue	X
43 (0x2B)	Encapsulated Interface Transport	X

16.2.7 Parameter Types

The SI series of products support the following parameter types: -

Type	Registers consumed	Details
UINT16	1	Unsigned 16-bit value
SINT16	1	Signed 16-bit value
UINT32	2	Unsigned 32-bit value
SINT32	2	Signed 32-bit value
SINT64	4	Signed 64-bit integer. Note: Usually within the SI series these are used with an inferred six decimal places.
STRING8	4	A String consisting of up to eight characters with two characters stored in each 16-bit register. Note: This string will be null terminated if less than eight characters, but not if all 8 characters are used for ASCII.
POINTER	1	This parameter is used to reference a value from another parameter. An example of it's use would be as the input parameter for a functional block – this parameter would contain a value representing the Parameter Address for the input value.

All parameter types that consume more than one 16-bit register hold their data with the most significant part first, at the lower address.

Examples: -

A SINT32 parameter at address 100 holds the most significant 16 bits at address 100 and the least significant 16 bits at address 101 (both registers must be read together with a single, multi-register read command).

A STRING8 parameter at address 110 holds the first pair of characters at that address (one 16 bit register used to hold two 8-bit chars, again most significant first), the second pair of characters reside at address 111 and so on, for a maximum of 4 registers (4 character pairs = 8 characters maximum), Note: Again all four registers must be read with a single, multi-register read command, and the string constructed accordingly. If the string is known to be only 1 or two characters long, the entire 4-register parameter must still be read as a single entity to ensure parameter integrity.

16.2.8 Parameter Map

The Orbit ACS Modbus Parameter Map is Document “503116 Orbit ACS Modbus Parameter Map – [SI100SI200.pdf](#)”, or “[503166 Orbit ACS Modbus Parameter Map – SI400.pdf](#)”, available on the Solartron Metrology Web Site.

The table at the bottom of the file shows descriptions for enumerated values.

16.2.9 ACS, Modbus Floating point

In order to provide 32 bit floating point type data for parameters, the ACS products provide a floating point interface to any parameter by way of an address offset. This provides an alternate address to read over Modbus, providing a floating point representation of any parameter.

To acquire an IEEE-754 floating point value for any parameter, add 8000 to the address of the parameter required and read 2, 16 bit registers in a multiple register read command. The data returned will be a floating point number for the parameter at address supplied -8000, i.e. Read address 8001 as a floating point will yield the floating point value for the parameter at address 1.

17 MEASUREMENT RESOLUTION, AVERAGING AND BANDWIDTH

The Orbit ACS has the ability to set the probes into three resolution options, 14 bit, 16 bit (default factory setting) and 18 bit. The table below shows the best resolution (1 bit that is theoretically possible) with different probe measurement ranges.

Range mm	0.5	1	2	5	10	20
Resolution μm (18 bit)	0.00	0.00	0.01	0.02	0.04	0.08
Resolution μm (16 bit)	0.01	0.02	0.03	0.08	0.15	0.31
Resolution μm (14 bit)	0.03	0.06	0.12	0.31	0.61	1.22

It is important to consider the resolution that can be displayed (no of decimal places) and set the probe resolution accordingly. The SI series can display up to 5 decimal places or 0.01 μm , so the probe resolution needs to be set to better than the displayed resolution where possible. Equally, it is of little value trying to set the display to a resolution of 0.01 μm if the probe cannot achieve this.

Averaging improves the signal to noise ratio, but reduces the measurement bandwidth. Generally, using a higher resolution requires more averaging. The averaging is expressed in terms of the number of base reading cycles for the probe where a reading cycle corresponds to 256 μs . The update rate of the Orbit ACS is 5mS (200Hz), an averaging of 16, corresponds to a bandwidth of approximately 240Hz. The default factory setting is 16.

18 MISCELLANEOUS

18.1 FIRMWARE UPGRADES

From time to time, enhancements may become available for the Orbit ACS range.

These product firmware upgrades can be implemented out using the Orbit3 Updater utility, via the USB Mini B port on the rear of the unit. The unit must be powered in the normal way as it is not powered via the USB lead.

The utility is part of the 'Orbit3 Support Pack for Windows'. The latest version can be downloaded from the Solartron Metrology website. Once installed, it is located here:

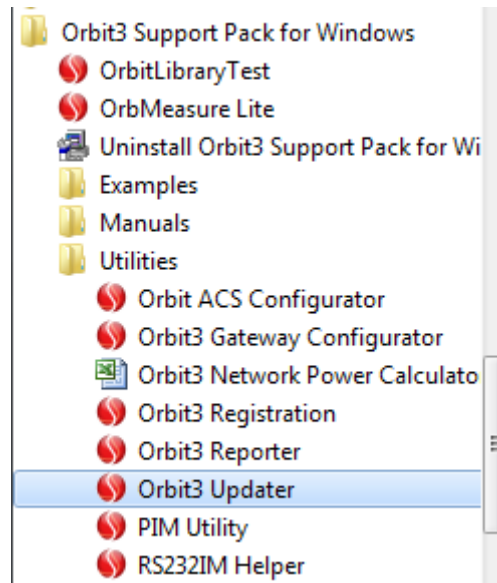

Follow the on screen instructions for the Updater.

Note. After running the firmware upgrade it is advisable to power cycle the Orbit ACS to allow the changes to fully take effect.

19 RETURN OF GOODS

Devices returned for service/repair/calibration should be shipped prepaid to your distributor or, if purchased directly from Solartron Metrology, to the relevant Sales Office.

The shipping container should be marked:
'For the Attention of the Customer Services Department'

The following information should accompany the device(s):

1. Contact details of company/person returning device, including return shipping instructions.
2. A statement of service required.
3. Description of the device fault and the circumstances of the failure, including application environment and length of time in service.

Alternatively there is a returns form available on our web site, follow the link to "Service Repair and Recalibration".

Please note:

A standard assessment charge is applicable on all non-warranty devices returned for repair.

Customer damage and any device found, upon inspection, to have no fault will be considered non-warranty.

Please contact the Sales Office or Distributor for warranty terms, service options and standard charges.

Adherence to these procedures will expedite handling of the returned device and will prevent unnecessary additional charges for inspection and testing to determine the condition.

Solartron Metrology reserves the right to repair or replace goods returned under warranty.

All repairs are guaranteed for 3 months (unless other-wise stated).

Solartron Metrology reserves the right to make changes without further notice to any products herein to improve reliability, function or design.

Solartron Metrology does not assume any liability arising out of the application or use of any product or circuit described herein, neither does it convey any licence under patent rights nor the rights of others.

20 SI400 APPENDIX

This sections describes the differences between the SI100/SI200 as described in this document and the operation of the SI400 unit.

20.1 SI400 SUMMARY

The SI400 is a device that can accommodate up to four channels, and as such does not provide the measurement computation facilities (A+B, A+B/2, A-B etc) that the SI100/SI200 provide, as the number of possible computations for a four channel device is prohibitive. It does however allow for each channel to monitor "Max-Min" as well as tracking channel input value and also provides Preset, ABS and ZERO controls for each channel, configured individually or all channels together.

The basic operation of the SI400, the menu system, its discrete inputs and outputs, adding digital probes etc, do however align with the ACS methodology, the menu's should be navigated the same and the parameters adjusted in the same manner.

20.2 SECTION 9.1 - SI100 AND SI200 DISPLAYS

As per all SI Series products, the SI400 has three main screens (excluding menu), which provide information as described below.

The charts shown on any of these screens include small triangles along the bottom edge which indicate the alarm setpoints for a given channel.

20.2.1 Screen 1 & 2

The first screen of the SI400 unit shows channels 'A' and 'B', with channel 'A' at the top and channel 'B' at the bottom. Each channel display provides a chart covering the full range of the probe as well as a reading, channel status (Range Error etc), measurement 'Mode' type ('Value' if tracking input or 'Max-Min') and a Pre/Zero/Abs indicator for each channel.

Screen two is the same as screen one except channels 'C' and 'D' are shown.

The format of screens 1 & 2 are shown below (note: Screen one, showing channels 'A' and 'B' is shown here): -

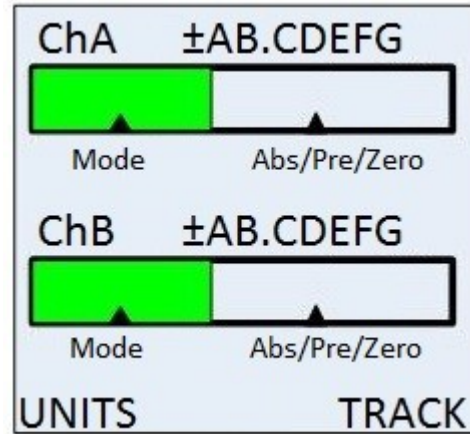

20.2.2 Screen 3

Screen three on the SI400 shows all four channels, with a value and chart only; as per below diagram: -

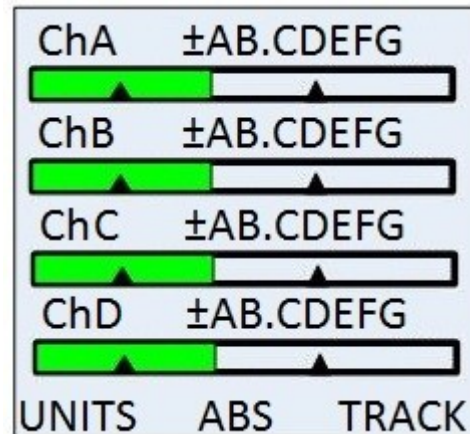

20.3 SECTION 9.2 - SI100 AND SI200 ACTIONS

The SI400 actions differ from that of the SI100 and SI200 because the computation methods provided by the SI100 & SI200 are not supported on the SI400, therefore the SI400 actions are used to control the resetting of Max-Min for any/all of the channels.

The SI400 actions are therefore as shown in the table below: -

ACTION	DESCRIPTION	COMMENT
RstALL	Reset all Max / Min	Reset Max/Min tracking for ALL Channels
RstAllMx	Reset all Max	Reset all Max tracking on ALL Channels
RstAllMn	Reset All Min	Reset all Min tracking on ALL Channels
RstAMax	Reset channel A Max	
RstAMin	Reset channel A Min	
RstBMax	Reset channel B Max	
RstBMin	Reset channel B Min	
RstCMax	Reset channel C Max	
RstCMin	Reset channel C Min	
RstDMax	Reset channel D Max	
RstDMin	Reset channel D Min	
Print	Print ASCII Output	For protocols that support ASCII output and the 'Print' function, this action causes the protocol to output as configured.
PresetAllNow	Apply Preset on ALL Channels	
ZeroAllNow	Apply Zero on ALL Channels	
AbsAllNow	Apply ABS on ALL Channels	
ChA_ZeroNow	Channel Zero	
ChA_PresetNow	Channel Preset	

ChA_ABSNow	Channel ABS	
ChB_ZeroNow	Channel Zero	
ChB_PresetNoz	Channel Preset	
ChB_ABSNow	Channel ABS	
ChC_ZeroNow	Channel Zero	
ChC_PresetNow	Channel Preset	
ChC_ABSNow	Channel ABS	
ChD_ZeroNow	Channel Zero	
ChD_PresetNow	Channel Preset	
ChD_ABSNow	Channel ABS	

Note: On the SI400, the main screen “Left button” and “Right Button” actions, as well as discrete inputs can be configured to any of the above options.

20.4 SECTION 9.3 - MENU SCREENS

The SI400 menu system is very similar to that of the SI100 and SI200 however menu's for Peak± and Preset are not included as the associated functionality is not included within the SI400.

Additionally, the Measurement menu page has different parameters to allow for the configuration of Value tracking or Max-Min for each channel instead of the Primary / Secondary computation options as per the SI100/SI200 units.

The Limits page also contains four sets of Hi/Low alarm limits, one for each channel.

20.5 SECTIONS 11 - OUTPUTS & 12 - DIGITAL INPUTS

The digital inputs can be configured to be 'off' (no action) or to prompt any of the actions as described in section 20.3 - Actions.

The digital outputs of the SI400 may be configured to reflect any of the following states: -

- Any Alarm
- No Alarms
- Any High Alarm
- Any Low Alarm
- Channel 1 High Alarm
- Channel 1 Low Alarm
- Channel 2 High Alarm
- Channel 2 Low Alarm
- Channel 3 High Alarm
- Channel 3 Low Alarm
- Channel 4 High Alarm
- Channel 4 Low Alarm
- Module 1 Under Range
- Module 2 Under Range
- Module 3 Under Range
- Module 4 Under Range
- Module 1 Over Range
- Module 2 Over Range
- Module 3 Over Range
- Module 4 Over Range

20.6 SECTION 15.1 - ORBIT ACS SERIAL COMMUNICATIONS PROTOCOL

The SI400 adheres to the same protocol specification as per the SI100 & SI200, however further configuration is provided so any of the four channels may be outputted, or 'ALL', in which case four lines of data are outputted at a time, with each channel consuming a line of output.

21 REVISION HISTORY

REVISION	DATE	COMMENTS
7	04/08/15	Added Installing the Orbit3 Support Pack for Windows® software
8	23/11/15	Added Display Error messages
9	18/01/19	Added AIM / LE support as well as Channel specific UOMs and individual Module Over / Under Range Digital output configuration added
10	15/10/2021	Improved Probe Errors for Orbit ACS Serial Communications Protocol